



**equipment & turn-key lines
for hot melt adhesive application**

add value to your production



mitsu converting world

WANT TO LAMINATE / TO COAT HIGH ADDED-VALUE PRODUCTS?

It's easy with the HIP-MITSU turn-key solutions: equipment, machines and systems for the application of hot melt adhesives, UV and PUR too.

The Company – innovation and steady research

HIP-MITSU, Italian company headquartered 15 minutes from the international Venice and Treviso airports, is one of the most qualified producers of Web-Coating and Web-Laminating equipment, machines and systems, in a field it has operated in for many years and where holds many international patents.

Application range : performances

The typical working range is referable to the following parameters: coating width from **0,3 to 6.000 mm**; high or low line speed, according to the end user's working process, with applications from **2 up to 900 m/min**; coating weight from **0,02 to 1.500 gr/sqm**, working temperature up to **240°C**, viscosity up to **120.000 mPas**.

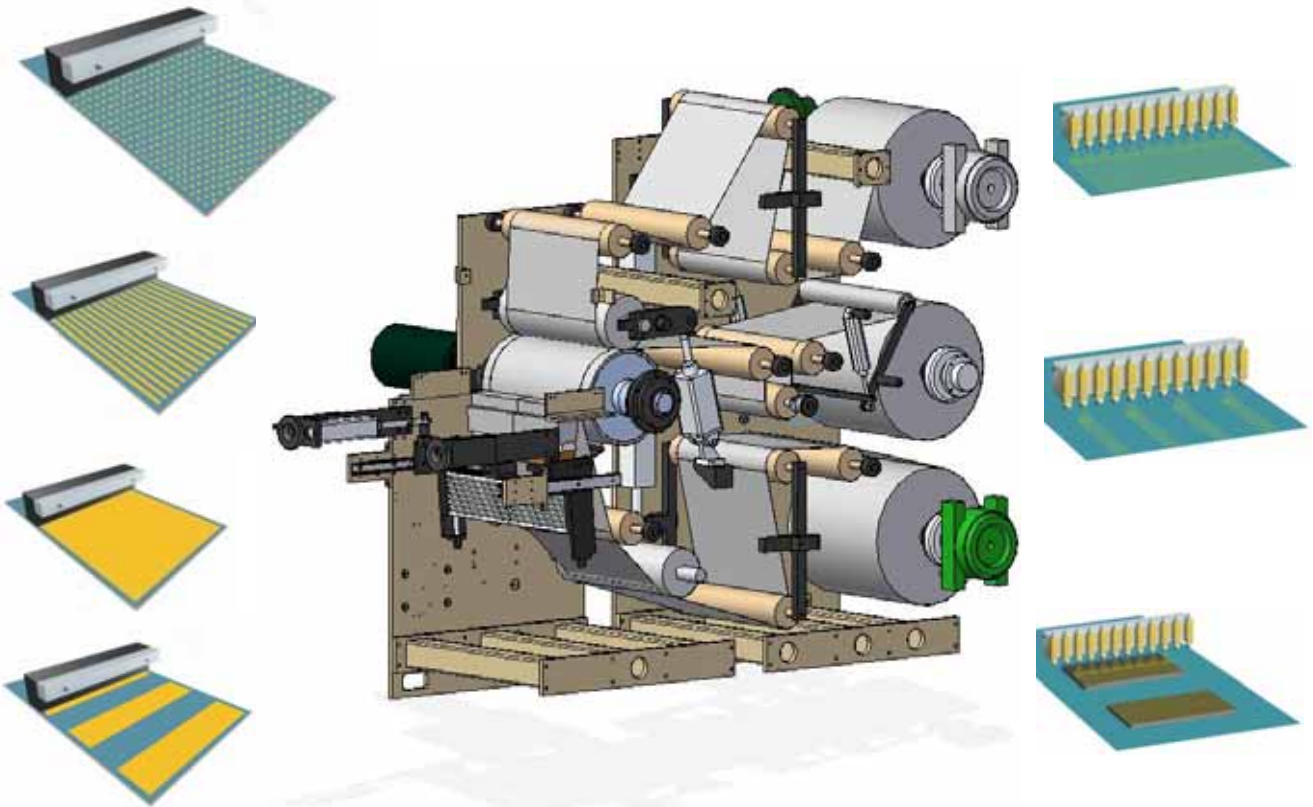

Product range : coating and laminating systems, equipment and lines

- Slot dies for hot melt adhesives
- Single and multiple automatic guns for hot melt adhesives contact-less application
- Roll systems for hot melt adhesives
- Continuous output melting units for hot melt adhesives
- Drum melters for hot melt adhesives
- Low speed Calenders/Web-Coaters for hot melt adhesives – for materials in rolls
- Low speed Calenders/Web-Coaters for hot melt adhesives – for materials in sheets and boards
- Low speed Web-Coating/Web-Laminating lines for hot melt adhesives

- High speed Calenders/Web-Coaters for hot melt adhesives
- High speed Web-Coating/Web-Laminating lines for hot melt adhesives
- Calender and Thermocalender

Retrofit of existing coating a/o laminating systems – a turn-key service

All HIP-MITSU systems can be easily installed both into a new and into an existing line; in this last case results are considerable increasing of the machine performances and production costs saving. All services offered by HIP-MITSU for the plant re-engineering and for the installation are listed into the specific section.

SLOT DIE FOR HOT MELT ADHESIVES

HIP-MITSU Slot Dies for hot melt adhesives – also UV curable and PUR - enable a precise and accurate adhesive application onto the substrate's surface. They can be installed within a limited space and enable a wide application range (see examples below). As they do not work in contact with any cylinder, no adjustment is required so coating width variations can take place within few minutes. They are fully synchronised with the main line leading to no contamination of the main line while coating.

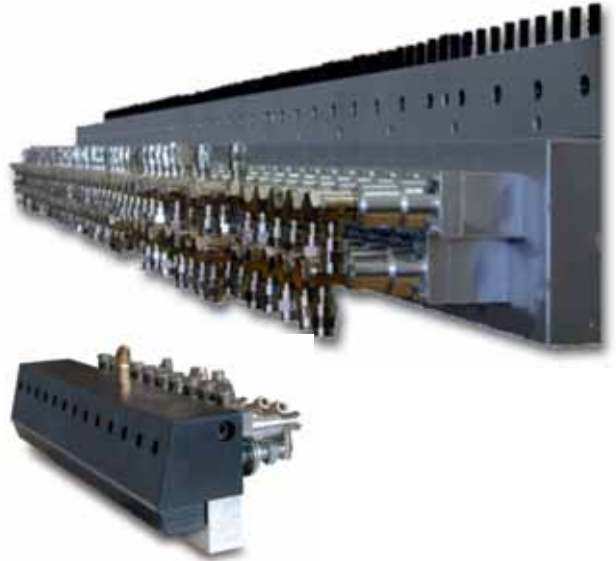

- Working temperature : up to 240 °C
- Viscosity : up to 120.000 mpas

- Working width : from 0,3 to 6.000 mm
- Coating weight : from 0,02 up to 1.500 gr/sqm
- Working speed : from 2 to 900 m/min

Applications achievable with HIP-MITSU high-precision Web-Coaters

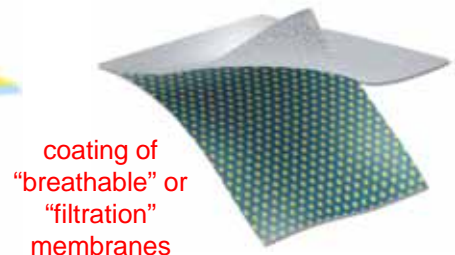
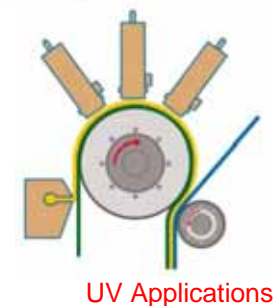
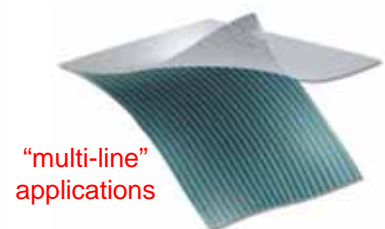
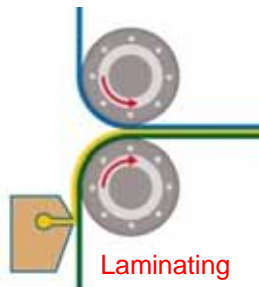
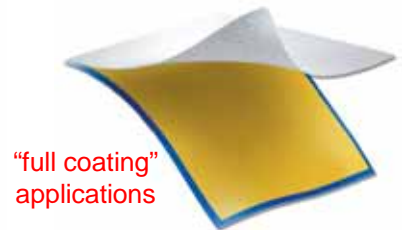
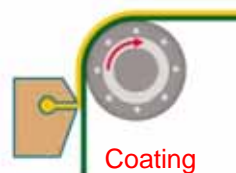

AUTOMATIC GUNS: SPRAY AND SPIRO

The HIP-MITSU “*contact-less*” automatic guns for hot melt adhesives enable a precise and accurate contact-less adhesive application onto the substrate’s surface. They can be installed within a limited space and enable a wide application range, as represented here below.

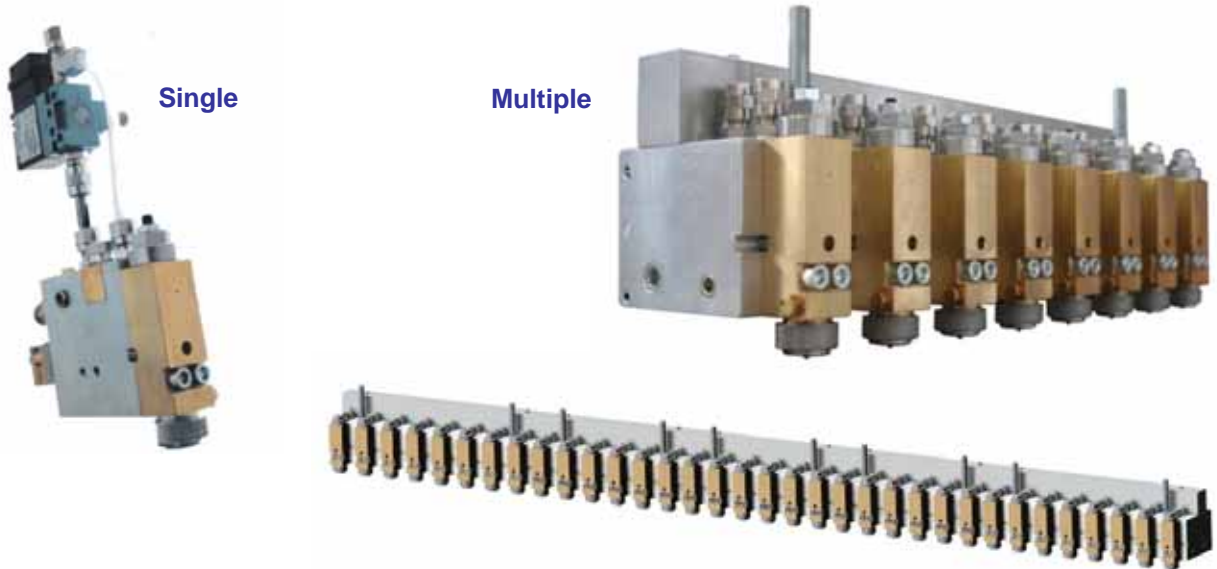

- Working temperatures : up to 240 °C

- Coating width : from 10 up to 6.000 mm

Applications achievable with high-precision HIP-MITSU “*contact-less*” guns

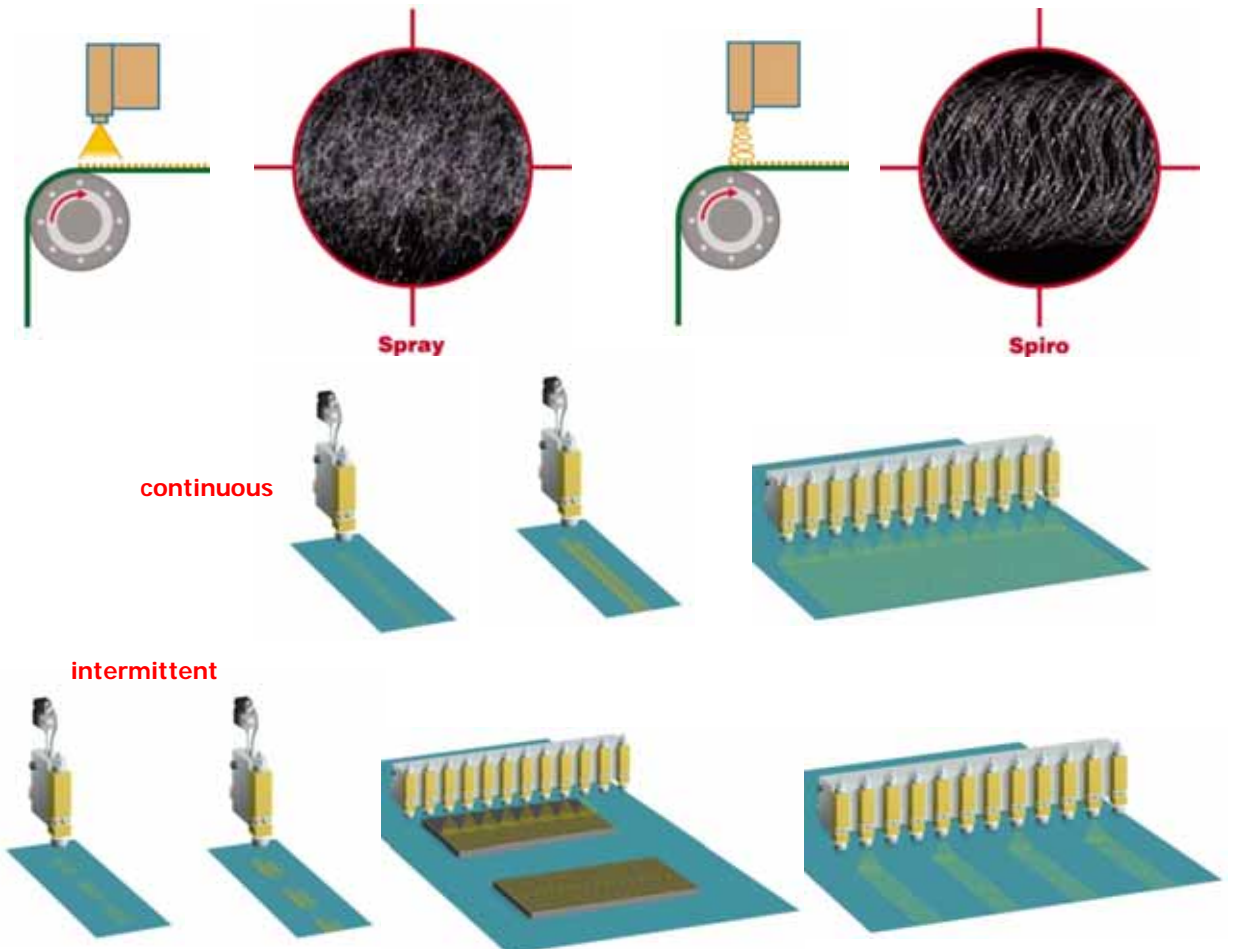

AUTOMATIC GUNS: FOR LINES AND DOTS

The HIP-MITSU automatic guns for hot melt adhesives enable a precise and accurate adhesive's application in form of lines and dots. They can be installed within a limited space and enable a wide application range, as represented here below.

Single



Multiple



- Working temperatures : up to 240 °C

- Coating width : from 10 up to 6.000 mm

Applications achievable with high-precision HIP-MITSU automatic guns for lines and dots

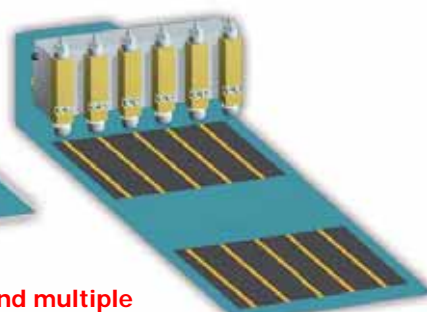
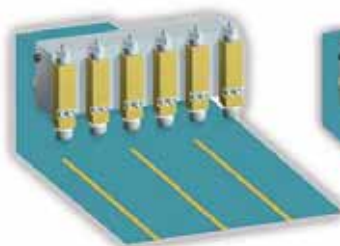
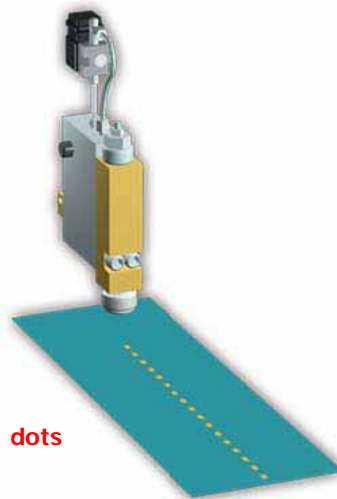
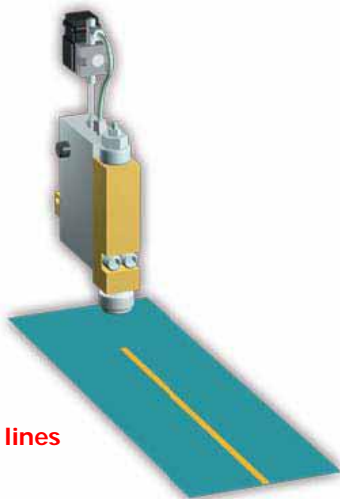

single and multiple

ROLL SYSTEMS FOR HOTMELT ADHESIVES

The HIP-MITSU roll systems for hot melt adhesives, including PUR, allow a precise and accurate adhesive coating on the substrate because of the complete synchronisation with the main line. The cleaning of the coating roll is particularly easy and quick. Easy to be integrated with the existing lines.



For wide web

- Working temperature : up to 210 °C
- Coating roll : flat or engraved
- Working width : up to 2.400 mm
- Working speed : from 2 to 50 m/min

For narrow web

- Working temperature : up to 210 °C
- Coating roll : flat or engraved
- Working width : up to 500 mm
- Working speed : any
- Coating weight set up : 5 sec
- Coating width set up : 5 min

Possible applications with HIP-MITSU high-precision roll systems

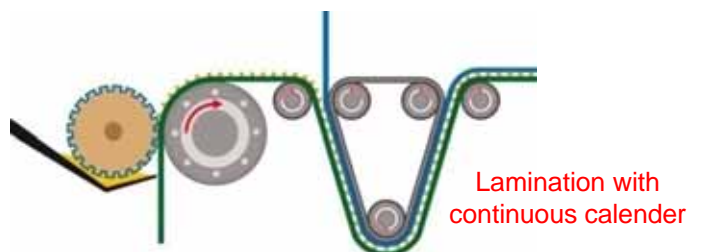
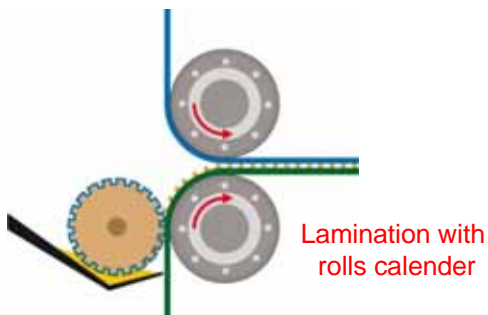
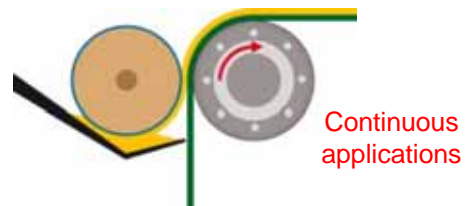
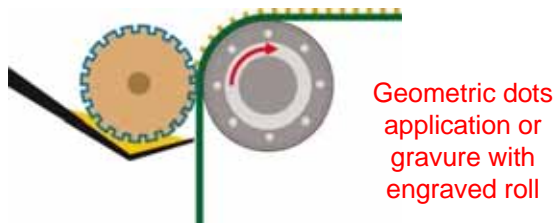

MELTERS for HOT MELT ADHESIVES

CONTINUOUS OUTPUT MELTING UNITS FOR HOT MELT ADHESIVES

MODEL MITSU and BA

HIP-MITSU continuous output melting units model MITSU and model BA for hot melt adhesives, also UV curable, give an appropriate answer to all needs concerning medium and low melting capacity. High precision gear pumps guarantee maximum precision in all conditions of use. The standardized and integrated design enables an easy use and quick and simple interface with the main line.



PERFORMANCES

Melt rate:

from 2,5 up to 160 kg/hour

Standard gear pumps available:

from 1 up to 66 cc/rev

Applications:

both continuous and intermittent

CONTINUOUS OUTPUT MELTING UNITS FOR HOT MELT ADHESIVES

FOR HIGH MELTING RATES

HIP-MITSU continuous output melting units model MITSU for hot melt adhesives, also reactive PUR and UV curable, give an appropriate answer to all needs concerning medium and high melting capacity. They are equipped with high precision gear pumps and guarantee maximum precision in all conditions of use, both continuous and intermittent. The standardized and integrated design enables an easy use and a quick and simple interface with the main line.



PERFORMANCES

Melt rate:

from 160 up to 1.000 kg/hour

Standard gear pumps available:

from 1 up to 420 cc/rev

Applications:

both continuous and intermittent

MELTERS for HOT MELT ADHESIVES

SCREW EXTRUDER for HOT MELT ADHESIVES - MODEL MITSU XX

HIP-MITSU's screw extruders for hot melt adhesives give an appropriate answer to all needs concerning small, medium and high melting capacity and adhesive's compounding.

Accurate mechanical construction guarantee maximum precision in all conditions of use.

The standardized and integrated design enables an easy use and quick and simple interface with the main line.



PERFORMANCES

Customised on demand

THERMO-REGULATED HOSES

HIP-MITSU produces a full range of thermo-regulated hoses, that turn out to be particularly suitable to convey hot melt adhesives and thermoplastic polymers.

Always supplied with Plug & Play connections for a rapid commissioning.

Perfectly insulated, they minimize energy spending combined with consequent reduction of production costs. Compatible with every kind of hot melt systems, they are available both in the standard and in the customised version.



STANDARD RANGE

Standard diameters available:

8; 13; 25 mm

Standard lengths available:

from 500 up to 40.000 mm

Electrical feeding:

either 380 Vac 50 Hz or on demand

Working temperature:

from 30 up to 210 °C (standard)

up to 300 °C in special operating mode

MELTERS for HOT MELT ADHESIVES

DRUM MELTERS FOR HOT MELT ADHESIVES - MODELS DM 20 AND DM 5

HIP-MITSU drum melters model DM 20 and DM 5 enable the use of hot melt adhesives, also reactive PUR and UV curable, butyls and sealants from 20-litre and 5-gallon drums.

They are equipped with high precision gear pumps and guarantee maximum precision in all conditions of use, both continuous and intermittent.

The standardized and integrated design enables an easy use and a quick and simple interface with the main line.



PERFORMANCES

Adhesive packaging:

20 litres and 5 gallons
(depending from the model)

Standard gear pumps available:

from 1 up to 66 cc/rev

Applications:

both continuous and intermittent

DRUM MELTERS FOR HOT MELT ADHESIVES - MODELS DM 200 AND DM 55

HIP-MITSU drum melters model DM 200 and DM 55 enable the use of hot melt adhesives, also reactive PUR and UV curable, butyls and sealants from 200-litre and 55-gallon drums.

They are equipped with high precision gear pumps and guarantee maximum precision in all conditions of use, both continuous and intermittent.

The standardized and integrated design enables an easy use and a quick and simple interface with the main line.



PERFORMANCES

Adhesive packaging:

200 litres and 55 gallons

Applications:

both continuous and intermittent

Number of gear pumps:

up to 2 independent ones

CALENDERS AND THERMOCALENDERS

- Working width : from 100 mm to 3.600 mm
- Working speed : from 2 to 900 m/min

- Calendering pressure : up to 20 kg/cm
- Thermoregulation: with water or oil up to 210 °C



examples of machine layout - design on demand

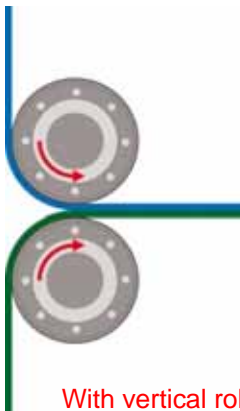

With vertical rolls

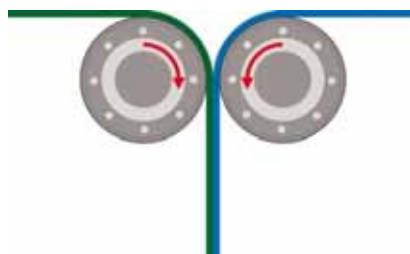

With horizontal rolls

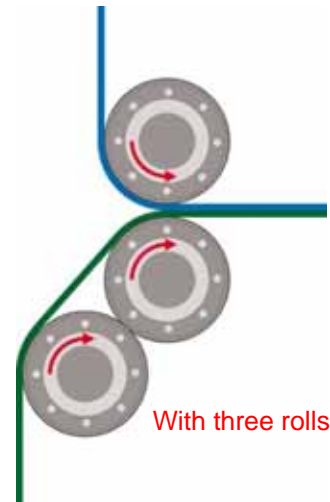

With three rolls

LOW SPEED: WEB-COATING AND LAMINATING

For low speed web-Coating and Laminating with hot melt adhesives – also PUR and UV curable - HIP-MITSU offers a full range of integrated solutions.

LAMINATOR for TWO LAYERS (ROLL to ROLL LAMINATION) for HOT MELT ADHESIVES

- Working width : from 100 to 3.600 mm
- Working speed : up to 80 m/min
- Coating weight : from 0,02 up to 1.500 gr/sqm

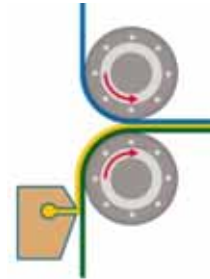

For the adhesive coating it's possible to install both HIP-MITSU Slot Die and Spray devices



- Compatible with any kind of winder and unwinder (new or already installed)
- Tread-up according to the specific features of the materials to be used
- Reliable and sound
- Integrated Control Desk

LOW SPEED: WEB-COATING AND LAMINATING

For low speed web-Coating and Laminating with hot melt adhesives – also PUR and UV curable - HIP-MITSU offers a full range of integrated solutions.

LAMINATOR for TWO LAYERS (ROLL to ROLL LAMINATION) for HOT MELT ADHESIVES

- Working width : from 100 to 3.600 mm
- Working speed : up to 80 m/min
- Coating weight : from 0,02 up to 1.500 gr/sqm

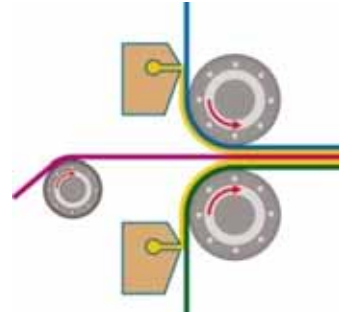

For the adhesive coating it's possible to install both HIP-MITSU Slot Die and Spray devices



- Compatible with any kind of winder and unwinder (new or already installed)
- Tread-up according to the specific features of the materials to be used
- Reliable and sound
- Integrated Control Desk

LOW SPEED: WEB-COATING AND LAMINATING

For low speed web-Coating and Laminating with hot melt adhesives – also PUR and UV curable - HIP-MITSU offers a full range of integrated solutions.

LAMINATOR for MATERIAL in SHEETS / BOARDS or ROLL to ROLL for HOT MELT ADHESIVES

- Working width : from 100 to 3.600 mm
- Working speed : up to 80 m/min
- Coating weight : from 0,02 up to 1.500 gr/sqm

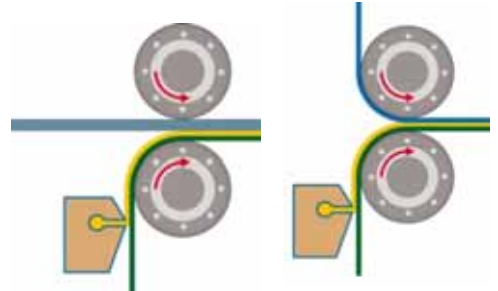

For the adhesive coating it's possible to install both HIP-MITSU Slot Die and Spray devices

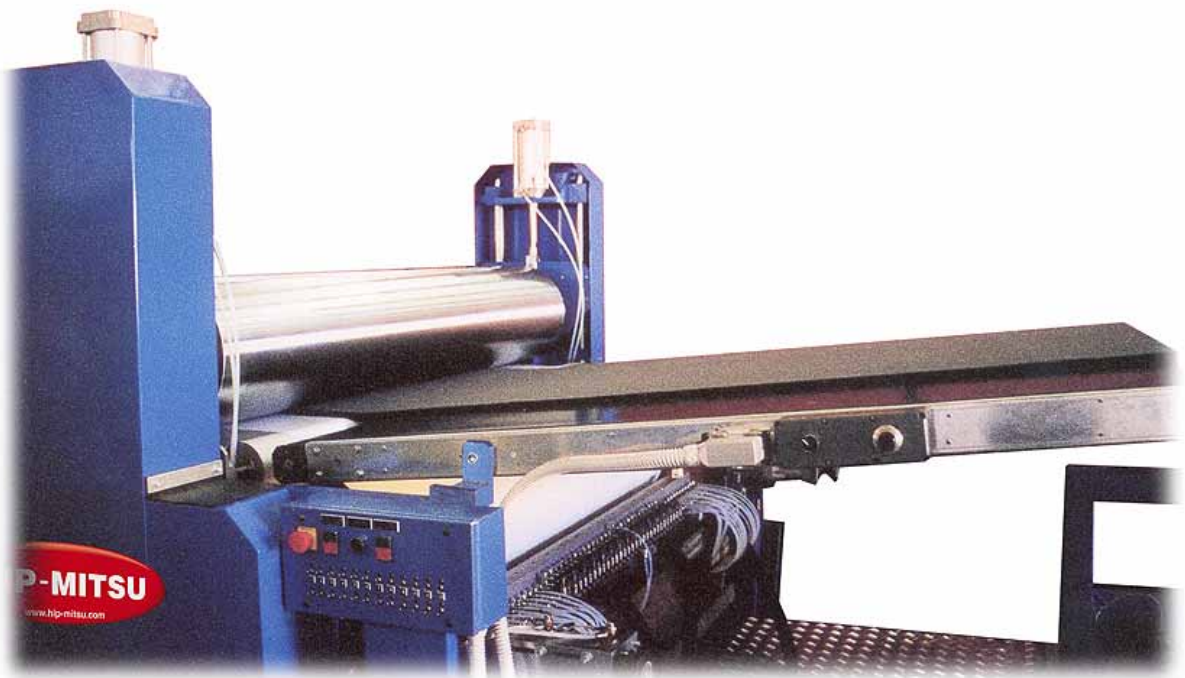

- Compatible with any kind of winder and unwinder (new or already installed)
- Tread-up according to the specific features of the materials to be used
- Reliable and sound
- Integrated Control Desk

LOW SPEED: WEB-COATING AND LAMINATING

For low speed web-Coating and Laminating with hot melt adhesives – also PUR and UV curable - HIP-MITSU offers a full range of integrated solutions.

LAMINATOR for MATERIAL in SHEETS / BOARDS or ROLL to ROLL for HOT MELT ADHESIVES

- Working width : from 100 to 3.600 mm
- Working speed : up to 80 m/min
- Coating weight : from 0,02 up to 1.500 gr/sqm

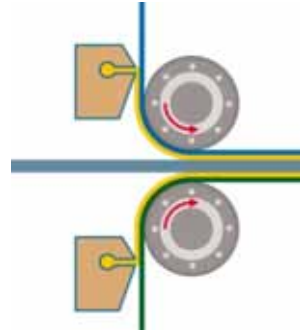

For the adhesive coating it's possible to install both HIP-MITSU Slot Die and Spray devices



- Compatible with any kind of winder and unwinder (new or already installed)
- Tread-up according to the specific features of the materials to be used
- Reliable and sound
- Integrated Control Desk

LOW SPEED: WEB-COATING AND LAMINATING

For low speed web-Coating and Laminating with hot melt adhesives – also PUR and UV curable - HIP-MITSU offers a full range of integrated solutions.



TURN-KEY LINES for TWO LAYERS (ROLL to ROLL) for HOT MELT ADHESIVES

- Working width : from 100 to 3.600 mm
- Working speed : up to 80 m/min
- Coating weight : from 0,02 up to 1.500 gr/sqm

For the adhesive coating it's possible to install both HIP-MITSU Slot Die and Spray devices

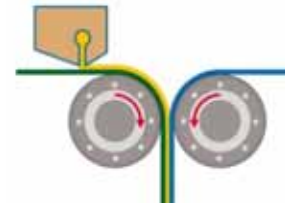

LOW SPEED: WEB-COATING AND LAMINATING

For low speed web-Coating and Laminating with hot melt adhesives – also PUR and UV curable - HIP-MITSU offers a full range of integrated solutions.



TURN-KEY LINES for TWO LAYERS (ROLL to ROLL) for HOT MELT ADHESIVES

- Working width : from 100 to 3.600 mm
- Working speed : up to 80 m/min
- Coating weight : from 0,02 up to 1.500 gr/sqm

For the adhesive coating it's possible to install both HIP-MITSU Slot Die and Spray devices

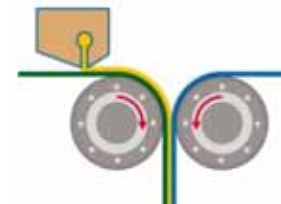

LOW SPEED: WEB-COATING AND LAMINATING

For low speed web-Coating and Laminating with hot melt adhesives – also PUR and UV curable - HIP-MITSU offers a full range of integrated solutions.



TURN-KEY LINES for TWO LAYERS (ROLL to ROLL) for HOT MELT ADHESIVES

- Working width : from 100 to 3.600 mm
- Working speed : up to 150 m/min
- Coating weight : from 0,02 up to 1.500 gr/sqm

For the adhesive coating it's possible to install both HIP-MITSU Slot Die and Spray devices

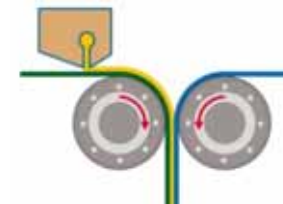

LOW SPEED: WEB-COATING AND LAMINATING

For low speed web-Coating and Laminating with hot melt adhesives – also PUR and UV curable - HIP-MITSU offers a full range of integrated solutions.



TURN-KEY LINES for TWO LAYERS (ROLL to ROLL) for HOT MELT ADHESIVES

- Working width : from 100 to 3.600 mm
- Working speed : up to 80 m/min
- Coating weight : from 0,02 up to 1.500 gr/sqm

For the adhesive coating it's possible to install both HIP-MITSU Slot Die and Spray devices

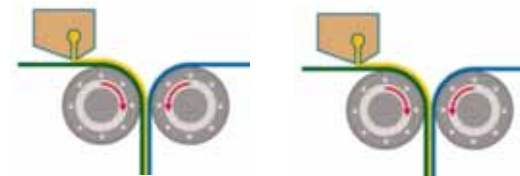

LOW SPEED: WEB-COATING AND LAMINATING

For low speed web-Coating and Laminating with hot melt adhesives – also PUR and UV curable - HIP-MITSU offers a full range of integrated solutions.



TURN-KEY LINES for TWO LAYERS (ROLL to ROLL) for HOT MELT ADHESIVES

- Working width : from 100 to 3.600 mm
- Working speed : up to 80 m/min
- Coating weight : from 0,02 up to 1.500 gr/sqm

For the adhesive coating it's possible to install both HIP-MITSU Slot Die and Spray devices

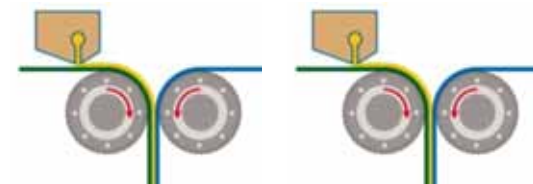

LOW SPEED: WEB-COATING AND LAMINATING

For low speed web-Coating and Laminating with hot melt adhesives – also PUR and UV curable - HIP-MITSU offers a full range of integrated solutions.

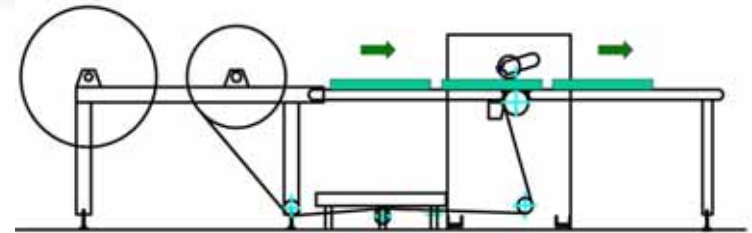
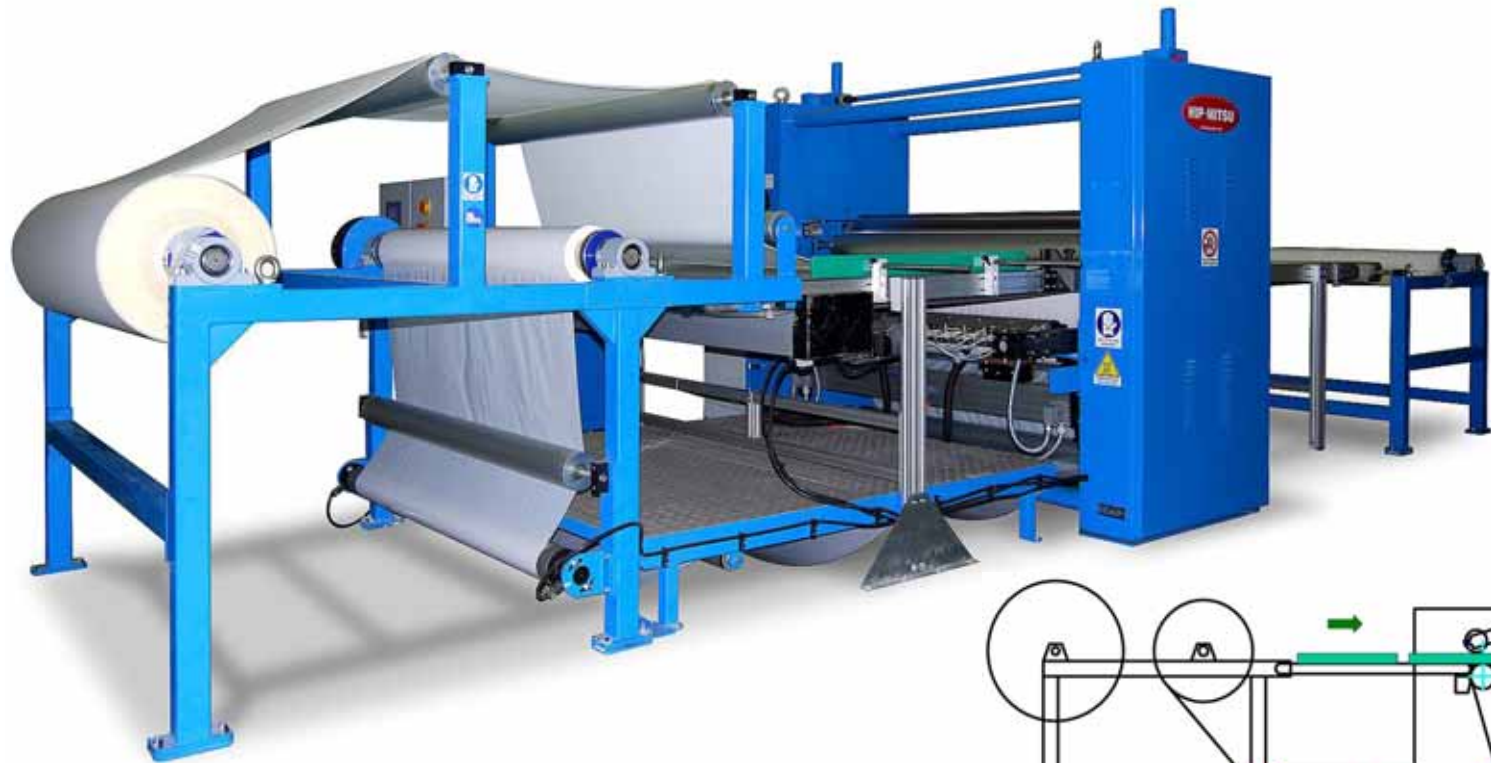

TURN-KEY LINES for TWO LAYERS (ROLL / ROLL or ROLL / SHEET) for HOT MELT ADHESIVES

- Working width : from 100 to 3.600 mm
- Working speed : up to 80 m/min
- Coating weight : from 0,02 up to 1.500 gr/sqm

For the adhesive coating it's possible to install both HIP-MITSU Slot Die and Spray devices

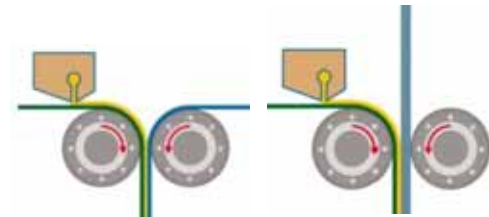

HIGH SPEED: WEB-COATING AND LAMINATING

For high speed web-Coating and Laminating with hot melt adhesives – also PUR and UV curable - HIP-MITSU offers a full range of integrated solutions.

HIGH-SPEED LAMINATORS for HOT MELT ADHESIVES

- Working width : from 100 to 3.600 mm
- Working speed : up to 900 m/min
- Coating weight : from 0,02 up to 1.500 gr/sqm
- Calendering pressure : up to 20 kg/cm
- With thermoregulated rolls too

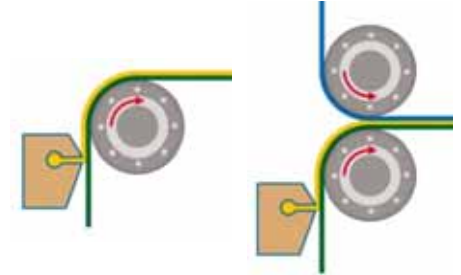

For the adhesive coating it's possible to install both HIP-MITSU Slot Die and Spray devices



- Compatible with any kind of winder and unwinder (new or already installed)
- Tread-up according to the specific features of the materials to be used
- Reliable and sound
- Integrated Control Desk

HIGH SPEED: WEB-COATING AND LAMINATING

For high speed web-Coating and Laminating with hot melt adhesives – also PUR and UV curable - HIP-MITSU offers a full range of integrated solutions.

HIGH-SPEED TURN-KEY LINES for HOT MELT ADHESIVES

(as general contractor)

- Working width : from 100 to 3.600 mm
- Working speed : up to 900 m/min
- Coating weight : from 0,02 up to 1.500 gr/sqm
- Calendering pressure : up to 20 kg/cm
- With thermoregulated rolls too

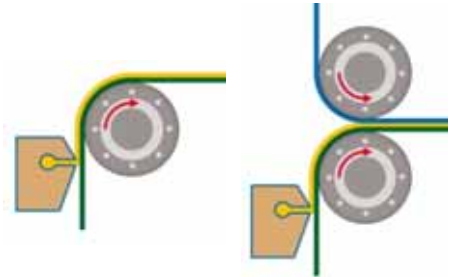

For the adhesive coating it's possible to install both HIP-MITSU Slot Die and Spray devices



LOW and HIGH SPEED: WEB-COATING

For low and high speed web-Coating and Laminating with hot melt adhesives – also PUR and UV curable - HIP-MITSU offers a full range of integrated solutions.

WEB-COATERS for HOT MELT ADHESIVES

- Working width : from 100 to 3.600 mm
- Working speed : any
- Coating weight : from 0,02 up to 1.500 gr/sqm

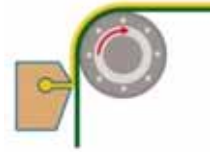

For the adhesive coating it's possible to install both HIP-MITSU Slot Die and Spray devices

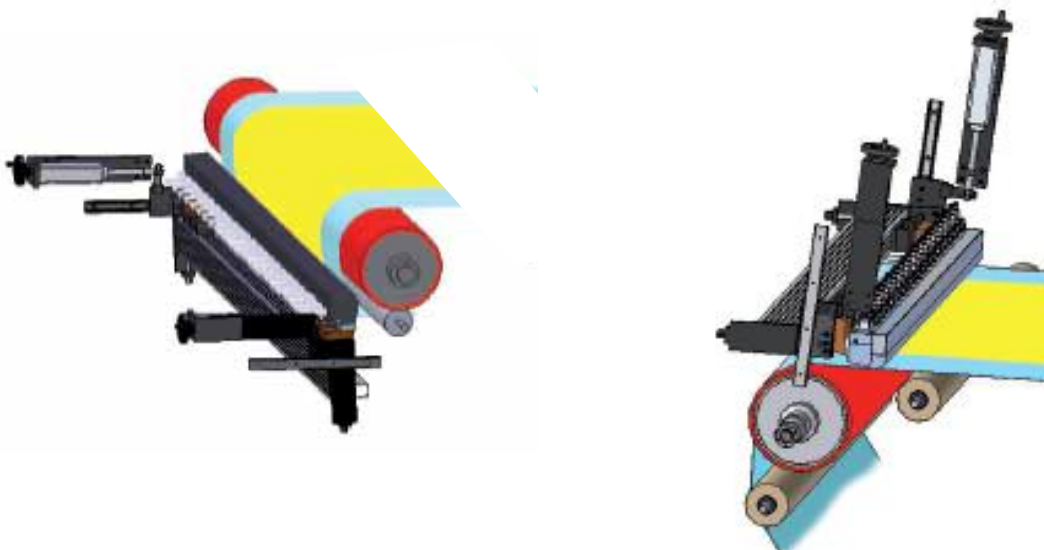

NARROW WEB: TURN-KEY SOLUTIONS

For the web-Coating and Laminating using hot melt adhesives – also PUR and UV curable – of narrow webs HIP-MITSU offers a full range of integrated solutions, both “Off-Line” and “In-Line”.

“OFF LINE” CONFIGURATION for WEB-COATING and LAMINATING of NARROW WEBS

- Working width : from 100 to 1.400 mm; Working speed : low and high

HIP-MITSU “Off-Line” Web-Coaters and Laminators are used for the application of hot melt adhesives, PUR and UV curable too. They can include hoses, adhesive’s application devices and melters (with continuous cyclus or for drums), web-guides, winders and un-winders, UV lamps, etc.

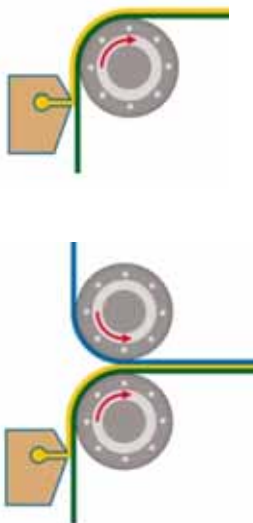

NARROW WEB: TURN-KEY SOLUTIONS

For the web-Coating and Laminating using hot melt adhesives – also PUR and UV curable – of narrow webs HIP-MITSU offers a full range of integrated solutions, both “Off-Line” and “In-Line”.

“IN LINE” CONFIGURATION for WEB-COATING and LAMINATING of NARROW WEBS

- Working width and speed : any

HIP-MITSU's “In Line” web-Coaters and Laminators for hot melt adhesives, PUR and UV curable too, can be easily installed on existing and new machines. Handy eyebolts are fitted for easy transportation and positioning. They are supplied, where required, with independent motorization and tension control.

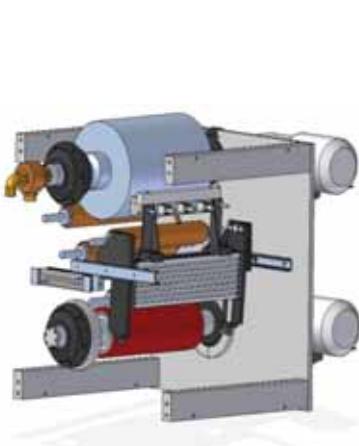
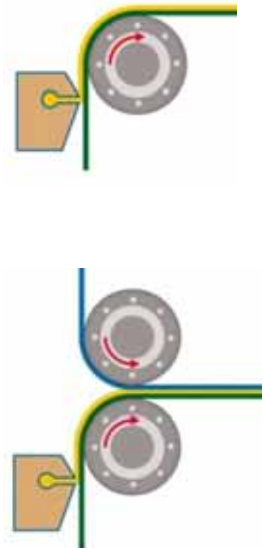

Web-Coater with chiller

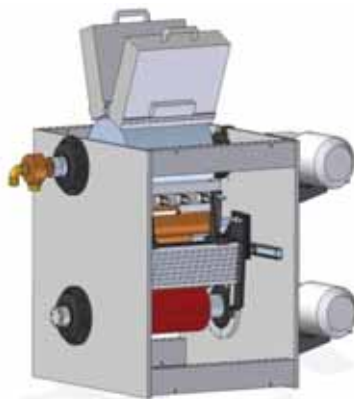

Web-Coater : integrated of UV lamps

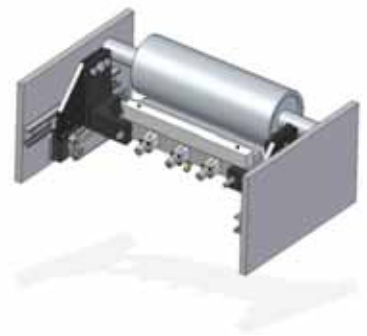

Web-Coater : compact configuration

RETROFIT OF EXISTING MACHINES

For retrofitting existing machines HIP-MITSU offers a full range of well-tested solutions to improve line's performances and to reduce production costs.

NOTHING'S LEFT TO CHANCE : SURE DEADLINE AND RESULTS



BEAM : INTEGRABLE into an EXISTING CALANDER

Working width : from 100 to 6.000 mm; Time required for the installation : 5 hours

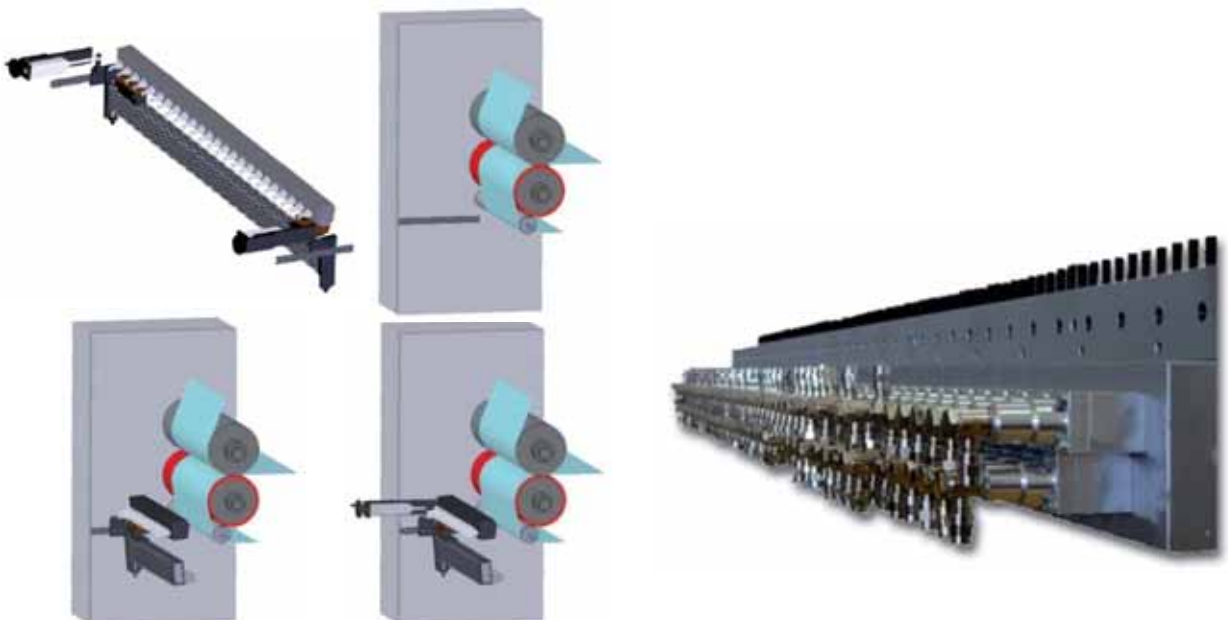

RETROFIT OF EXISTING MACHINES

For retrofitting existing machines HIP-MITSU offers a full range of well-tested solutions to improve line's performances and to reduce production costs.

FRAME : INTEGRABLE into a EXISTING CALANDER

Working width : from 100 to 6.000 mm; Time required for the installation : 5 hoursore

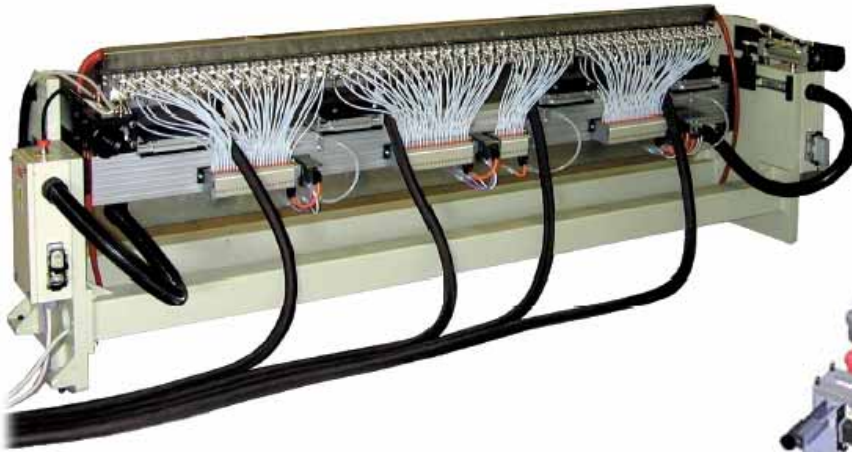

CUSTOMIZED WEB-COATERS and LAMINATORS

Easy to be integrated into a production line; Independent motorization available

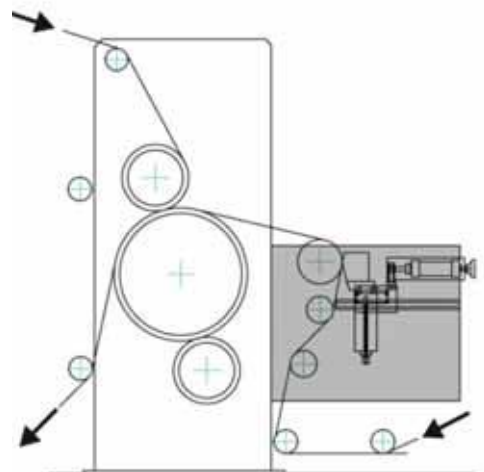

GENERAL SERVICES

Competence Center – Production Lines for tests execution

HIP-MITSU *Competence Center*, equipped with the most advanced technologies and *production lines*, helps Customers during the application development enabling adhesive, polymers and materials testing.

Free Demo in real production's conditions are available every day on HIP-MITSU equipment, lines and systems.

A full assistance to customers during each phase of the project

- *Polymer/adhesive's research*
- *Sampling*
- *Project engineering*

Training Courses for end users

HIP-MITSU offers to its Customers complete training courses including both theoretical and practical sections.

Full papers - available in five languages - are supplied at each course to all participants.

Courses available for : *line operator; mechanical maintenance staff; electrical maintenance staff.*

Periodical Maintenance Service

Complete programs of periodical maintenance, which can take place both at HIP-MITSU and customer's site.

Spare Parts

HIP-MITSU spare parts service avails itself of the main international couriers ensuring spare parts delivery the day after the order receipt

A worldwide sales network

HIP-MITSU is worldwide locally present with a network of highly skilled professionals, who ensure a quick and qualified answer.

First Installation and Technical Assistance

HIP-MITSU technical assistance service is hold by a team of skilled English-speaking technicians operating worldwide for many years, who ensures a highly professional support both during the installation and the technical assistance.

HIP-MITSU working team includes : process engineers; mechanical maintenance staff; electrical maintenance staff; electronic maintenance staff; PLC software technicians; PC software technicians.

HIP-MITSU: a "Cappuccino" Idea

HIP-MITSU technology is really a "cappuccino" idea : as milk adds value to a coffee cup, so it adds value to the roll goods produced by the end user.



add value to your production

HEAD OFFICE

I - 31027 SPRESIANO (TV) Italy - Via A. Volta, 1
Tel. + 39 0422 887.566 r.a. - Fax + 39 0422 887.337 - <http://www.hip-mitsu.com> e-mail: info@hip-mitsu.com